

THIS INFORMATION IS CONFIDENTIAL AND IS DISCLOSED TO YOU ON CONDITION THAT NO FURTHER DISCLOSURE IS MADE BY YOU TO OTHER THAN TETULL PERSONNEL WITHOUT WRITTEN AUTHORIZATION FROM TETULL LTD.

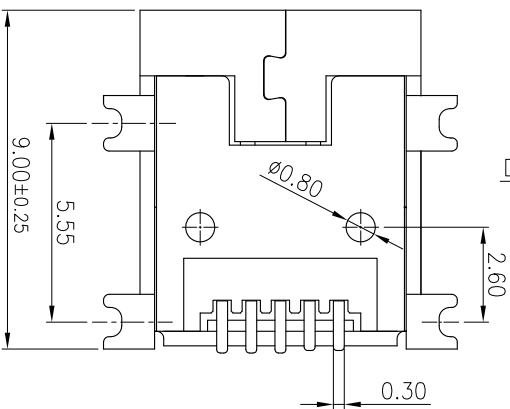
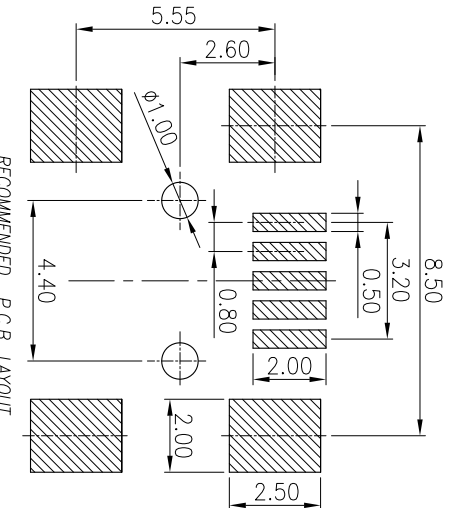
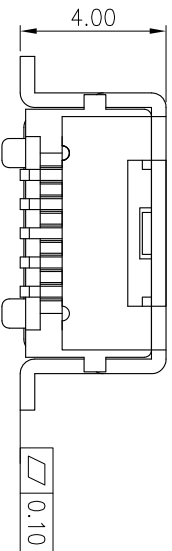
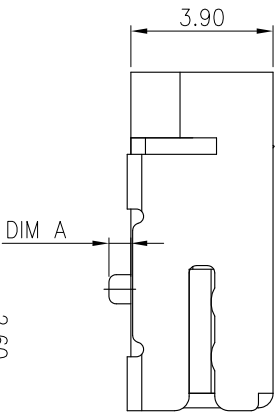
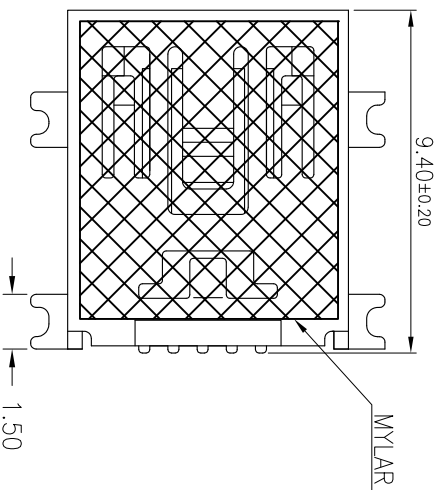
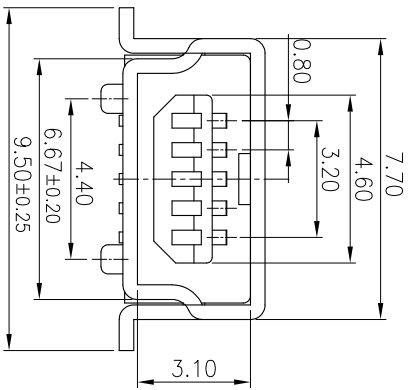
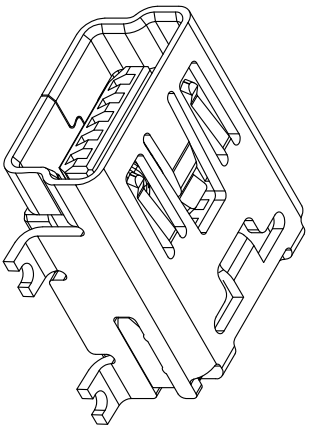

- SPECIFICATIONS:
- ELECTRICAL CHARACTERISTICS
 - 1-1. VOLTAGE RATING: 30V AC
 - 1-2. CURRENT RATING: 10A
 - 1-3. CONTACT RESISTANCE: 50 milliohms MAX.
 - 1-4. INSULATION RESISTANCE: 100 Megohms MIN.
 - 1-5. DIELECTRIC WITHSTANDING VOLTAGE: 500V AC FOR 1 MINUTE.
 - MECHANICAL CHARACTERISTICS
 - 2-1. RETENTION FORCE: MIN. 300gf / PIN
 - 2-2. DURABILITY: 5000 CYCLES
 - OPERATING TEMPERATURE: -40°C ~ 85°C

ITEM	P/N	DIM A	PACK	NOTE
1	1030501AR001	1.00	REEL & TAPE	W/MYLAR
2	1030501AR002	0.60	REEL & TAPE	W/MYLAR
3	1030501AT003	1.00	TUBE	W/O MYLAR

NO	DESCRIPTION	QTY	MATERIAL	PLATING & COLOR
C	SHIELD	1	COPPER ALLOY 0.30T	Ni&Tin PLATED
B	TERMINAL	5	COPPER ALLOY 0.25T	Gold Flash On Contact Area Tin plated on Solder tail All over Nickel Plated.
A	HOUSING	1	THERMOPLASTIC UL94-V0	BLACK

UNLESS OTHERWISE SPECIFIED TOLERANCES

DECIMALS:	ANGLES:
X : ±0.5	X : ±2°
X.X : ±0.3	X.X : ±1°
X.XX : ±0.2	

TETULL

Mini usb FM 5P SMT TYPE

PART NO. 1030501AX00X
DWN JAMES 2015.09.25

CHKD
APVD

SCALE 1:1 UNIT: mm SHEET: 10F1 REV: A

CUSTOMER COPY

REV	ECN NO	OR DESCRIPTION	REVISED	DATE
A		PRODUCT RELEASE	JAMES	2015.09.25